



















- 1 
- 2 
- 3 
- 4 
- 5 
- 6 
- 7 
- 8 
- 9 
- 10 
- 11 
- 12 
- 13 
- 14 
- 15 
- 16 
- 17 
- 18 

STANDARDUTFÖRANDE

- **GN 614.6-K:** svartoxiderad stålkropp, låspinne av sätthärdat och svartoxiderat stål.
- **GN 614.6-KN:** Kropp av AISI 303 rostfritt stål med låspinne av AISI 303 nitrerat rostfritt stål.

FJÄDER

Fjäder av rostfritt stål AISI 631 LHC med normal kraft.

KÄNNETECKEN OCH ANVÄNDNING

GN 614.6 fjädrande tryckskruv används huvudsakligen vid tillverkning av verktyg som fjäderstopp samt för tryck- och blockeringsfunktioner. Rekommenderad tolerans för hål för låspinnen = H7.

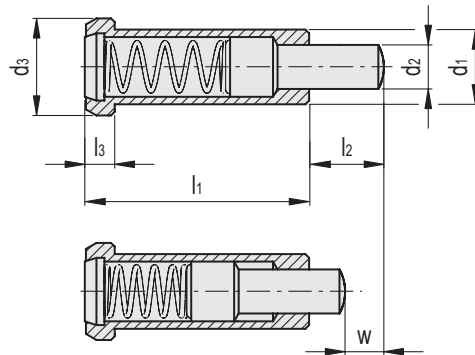
**GN 614.6-K**

Kod	Benämning	d1 -0.05	d2	d3	l1	l2	l3	w	Fjäderförspänning [N]	Fjäder max belastning [N]	
GN.32701	GN 614.6-6-K	6	2.7	8	20	6	3.2	3.5	10	22	4
GN.32703	GN 614.6-8-K	8	3.9	10	24	8	3.2	4.5	30	88	8
GN.32705	GN 614.6-10-K	10	5.9	13	30	10	4	5.5	42	110	16
GN.32707	GN 614.6-12-K	12	7.9	16	36	12	5	6.5	50	130	27

GN 614.6-KN

Kod	Benämning	d1 -0.05	d2	d3	l1	l2	l3	w	Fjäderförspänning [N]	Fjäder max belastning [N]	
GN.32702	GN 614.6-6-KN	6	2.7	8	20	6	3.2	3.5	10	22	4
GN.32704	GN 614.6-8-KN	8	3.9	10	24	8	3.2	4.5	30	88	8
GN.32706	GN 614.6-10-KN	10	5.9	13	30	10	4	5.5	42	110	16
GN.32708	GN 614.6-12-KN	12	7.9	16	36	12	5	6.5	50	130	27